

Solid  
Surface  
Collection





[www.oliverisinks.com](http://www.oliverisinks.com)

## **Oliveri** | Inspirational designs for your kitchen

Nothing compares to the beauty of a solid surface bench top. From the cool, understated majesty of granite, through to the dramatic effect of a polished Jarrah top, solid surfaces demand attention and create a focal point for your kitchen. Oliveri have used their knowledge of international style to produce a range of inspirational sinkware designs that takes full advantage of solid surface bench tops. Designs range from the large capacity, extra-wide



Manhattan and Dallas styles, to the more conventional Monet and bowl-only designs that fit the standard 600mm bench top. Oliveri have also taken the practicality of the solid surface bench top to a new level, with a range of genuine Oliveri accessories that work with your Oliveri sink, even when it's undermounted. Now your solid bench top can also be transformed into a total food-processing centre. If it's not an Oliveri, it's a compromise.



MH886U shown with AC73 Stainless Steel Utility Tray supplied as standard. Shown with optional extra MG513 Mixer Tap.

## Contents

- 04 Manhattan**  
America's choice
- 06 Dallas**  
A family favourite
- 08 Monet Undermount**  
Style for the solid surface
- 10 Titan**  
Capacity with style
- 12 Compact Sinks**  
Traditional style undermounted
- 14 Solitaire**  
The versatile all-rounder
- 15 Accessories**  
Beyond a sink
- 16 Tapware**  
The perfect partner
- 18 Specifications & dimensions**



www.oliverisinks.com

# Manhattan | America's choice

Inspired by a country where they like their appliances a little bigger than the rest of the world, Oliveri have recognised the need for extra size and have created an extra capacity sink with an American style. The Superb Bowl is the largest in the Oliveri range and is spacious enough to take just about any roasting dish, wok or baking tray. When size matters, the only choice is Manhattan from Oliveri.



**AC73 Stainless Utility Tray**  
Extend the versatility of your Manhattan sink.



**Superb Bowl**  
One of the largest capacity bowls in the Oliveri Range has the AC80 Bowl Protector included as a standard accessory.



**Satin Finish**  
The new MH882U, MH882-1, MH886-1 sinks, feature an attractive satin finish to the drainer and rim.



## Included Accessories



**AC14**  
Basket Waste



**AC71**  
Stainless Steel Drainer Basket  
(MH885U/886U/886-1)



**AC72**  
'D' Colander  
(MH885U/886U/886-1)



**AC73**  
Stainless Steel Utility Tray  
(MH885U/886U/886-1)



**AC74**  
Solid Timber preparation Board  
(MH885U/886U/886-1)



**AC80**  
Bowl Protector

MH886U shown with AC80 Bowl Protector supplied as standard and MG513 Mixer Tap as an optional extra.



## Features



**Maxi Bowl (MH885U/6U)**  
This generous bowl is designed with a unique accessory lip to cater for the range of genuine Oliveri Accessories.



**1/2 Bowl (MH883U/4U)**  
This traditional half-sized bowl is still large enough to be the perfect partner for the Superb Bowl.



**Basket Waste**  
No more lost plugs. Push down to seal, pull up to drain and strain then remove to empty. The Manhattan is supplied standard with basket wastes.



**18 Gauge Stainless Steel**  
Nothing lasts as well as stainless steel, and your 18 gauge (1.2mm) Oliveri sink will endure many years of daily use.

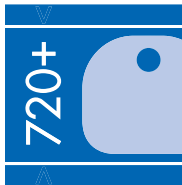

**Extra Wide Bench top**  
Size does make a difference. The super size of the Manhattan requires a larger 720mm bench top. (MH880U excluded)



**Oliveri Logo**  
The Oliveri signature represents over 50 years of world class sinkware manufacture in Australia. If it's not an Oliveri, it's a compromise.



**MH880U**



**MH883U**



**MH884U**



**MH885U**



**MH886U**



**MH886-1** (satin finish)



**MH882U** (satin finish)



**MH882-1** (satin finish)

## Optional Accessories



**AC82**  
Bowl Protector  
(MH885U/886U/886-1)



# Dallas | A family favourite

Every kitchen has a few favourite items, such as a much loved roasting pan or that special serving platter. We believe the Oliveri Dallas will be added to that list. The huge 'D' shaped bowl is designed to fulfil the needs of a family and ensures that this Oliveri sink will win a place in your kitchen too.

[www.oliverisinks.com](http://www.oliverisinks.com)



**Undermount or Topmount**  
You choose the fitment that suits your lifestyle.



**AC73 Stainless Utility Tray**  
Extend the versatility of your Dallas sink.

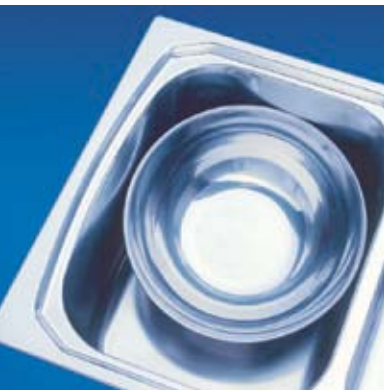

**Gourmet Bowl**  
Extra Large bowl indulges your culinary creativity.



## Included Accessories



DA834-1 shown with MG513 Mixer Tap as an optional extra.



## Features



### Accessory Lip

The Maxi Bowl is designed with a unique accessory lip to cater for a range of genuine Oliveri Accessories.



### Basket Waste

No more lost plugs. Push down to seal, pull up to drain and strain then remove to empty. The Dallas is supplied standard with basket wastes.



### 18 Gauge Stainless Steel

Nothing lasts as well as stainless steel, and your 18 gauge (1.2mm) Oliveri sink will endure many years of daily use.

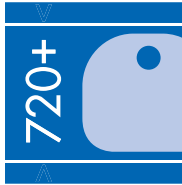

### Extra Wide Bench Top

Size does make a difference. The super size of the Dallas requires a larger 720mm bench top.



### Oliveri Logo

The Oliveri signature represents over 50 years of world class sinkware manufacture in Australia. If it's not an Oliveri, it's a compromise.



DA833U



DA834U



DA833-1 (satin finish)



DA834-1 (satin finish)

### Oliveri in the laundry

The large capacity of Manhattan and Dallas make them a stylish alternative for the laundry.



MH882-1 (Shown with AC80 & optional MG513 Mixer)

## Optional Accessories



AC82

Bowl Protector



www.oliverisinks.com

# Monet Undermount | Style for the solid surface

The Monet Undermount collection of stainless steel sinks have been designed to fit a standard 600mm solid surface bench top without compromising Oliveri's legendary style and practicality. The intelligent design and range of genuine Oliveri accessories allows you to enjoy all the benefits of a smooth-surface bench top combined with the sophistication of an Oliveri sink.



**AC73 Stainless Utility Tray**  
Extend the versatility of your Monet sink.



**Accessory Lip**  
Suits Oliveri's custom designed accessories.



**The Perfect Fit**  
Undermounts into a standard 600mm bench top.



## Included Accessories



MO70U shown with PS113/1 Mixer Tap as an optional extra.



## Features



### Tap Landing

The mixer tap is only mounted through the solid area of the bench top. This makes the tap easier to install and more stable when fitted.



### Bridge

The bowls of the Oliveri Undermount Collection are joined by a solid supporting bridge. This means there are no weak areas between bowls.



### Off Centre Outlets

Oliveri designers have placed the drain outlets towards the rear of the bowl to give you the maximum amount of useable space below the sink.



### 18/10 Stainless Steel

Oliveri sinks are manufactured from genuine 18/10, 304 grade stainless steel, for optimum hygiene and durability.



### Oliveri Logo

The Oliveri signature represents over 50 years of world class sinkware manufacture in Australia. If it's not an Oliveri, it's a compromise.



MO70U



MO71U



MO72U



MO450U (Alternative Installation Shown)



MO70U (Shown with AC72, AC74, AC73 & optional PS113/1)

## Optional Accessories



AC71

Stainless Steel Drainer Basket



AC82

Bowl Protector (MO450U)



AC72

'D' Colander (MO450U)



AC73

Stainless Steel Utility Tray (MO450U)



AC74

Solid Timber Preparation Board (MO450U)



www.oliverisinks.com

## Titan | Capacity with style

If you enjoy entertaining, cooking for a group or just experimenting at home, you'll find the Titan makes cleaning up a breeze. With an impressive 65 litre capacity, it is big enough to handle the largest roasting pan, tray or wok. Its square lines enhance the minimalist designs of today's modern kitchens and it is designed to be undermounted in a standard 600mm solid surface benchtop.



### Included Accessories



AC14  
Basket Waste



AC89  
Stainless Steel  
Bowl Protector

TN890U shown with AC89 Stainless Steel Bowl Protector and MV617/6 Mixer Tap as an optional extra.



**TN890U**

**Choose a partner**

For the ultimate in practicality and versatility, the Oliveri 890U can be partnered with a secondary bowl.



**TN890U (left) partnered with PE350U (right)**



**TN890U (left) partnered with MO455U (right)**

**Twice the space**

The extra wide, deep bowl allows you to fully immerse baking trays and pans.



**Optional Accessories**



**AC16**  
Benchtop Drainer Tray



**AC15**  
Timber Preparation Board (PE350U)



**AC18**  
'D' Colander (PE350U)

**18**  
GAUGE

**18 Gauge Stainless Steel**

Nothing lasts as well as stainless steel, and your 18 gauge (1.2mm) Oliveri sink will endure many years of daily use. (TN890U)



## Compact Sinks

## Traditional styles undermounted

Oliveri have an impressive range of single and double bowl sinks in variety of sizes to suit the kitchen designer in us all. These models offer a contemporary take on the traditional shape. Designed for undermounting, they fit into standard 600mm solid surface benchtops.

[www.oliverisinks.com](http://www.oliverisinks.com)



### Included Accessories



AC14  
Basket Waste

NP650U (left) is partnered with PE350U (right) and shown with MG513 Mixer Tap as an optional extra.



**DU490U** (left) partnered with **DU430U** (right)



**DU490U** (left) partnered with **DU485U** (right)



**DU490U**



**NP650U** (left) partnered with **MO455U** (right)



**NP650U**



**PE30U**



**PE350U** (left) partnered with **MO460U** (right)



**PE350U**

## Optional Accessories



**AC01**

Solid Timber Preparation Board (DU430U)



**AC03**

Stainless Steel Drainer Basket (PE30U/350U,DU430U)



**AC16**

Benchtop Drainer Tray



**AC02**

¾ Bowl Colander (DU485U)



**AC15**

Timber Preparation Board (PE350U)



**AC18**

'D' Colander (PE350U)



www.oliverisinks.com

# Solitaire | The versatile all-rounder

For those who love the simplicity of round bowls, Solitaire offers a choice of sinks that combine beauty and functionality. These single and double bowl sinks will enhance your solid surface and even offer a choice of installations to suit individual tastes. The custom designed accessories equip these sinks to assist in a variety of food preparation duties whilst maximizing bench space.

LR50U-1TH shown with MV617/6 Mixer Tap as an optional extra.



LR510

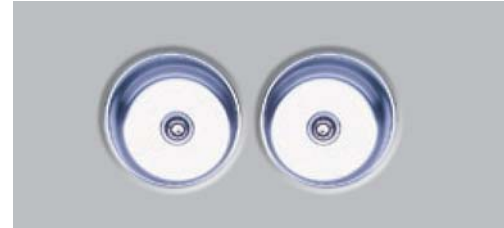

LR510 X 2



LR510 X 2 with optional AC53

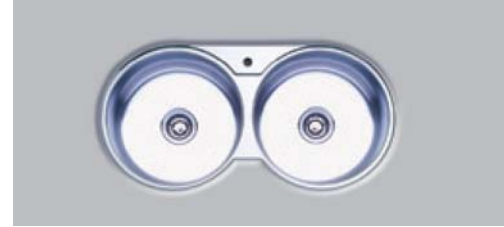

LR50U-1TH (tap mounted on sink)

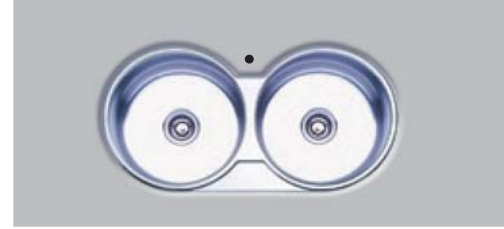

LR50U-NTH (tap mounted through benchtop)

### Accessory Lip

This ingenious feature allows Oliveri accessories to be used even when the sink is Undermounted.

### Included Accessories



AC14  
Basket Waste



AC53  
Stainless Steel Utility Tray  
(LR50U)

### Optional Accessories



AC50  
Solid Timber Preparation  
Board



AC51  
Stainless Steel Drainer  
Basket



# Accessories | Beyond a sink

The more you use your Oliveri sink the more you'll enjoy its sophisticated and functional design. The larger and deeper bowls make washing up easier and the impressive range of accessories transform any Oliveri sink into a total food processing centre. For instance, take the solid timber preparation board. In the morning you can use it for making sandwiches, at lunchtime it's simply perfect for preparing a salad, and when evening falls it even doubles as a stylish impromptu cheese board. Just one of the quality accessories that make Oliveri more than just a sink.



AC50

**Timber Preparation Board**

The knife-friendly hardwood finish has a unique cutaway design. Solitaire



AC74

**Timber Preparation Board**

Fits into bowl to tip chopped vegetables into the colander. Dallas, Monet

MH885/6  
MH885U/6U  
MH886-1



AC01

**Timber Preparation Board**

The knife-friendly hardwood timber board fits over bowl. DU430U



AC15

**Timber Preparation Board**

Fits into bowl to tip chopped vegetables into the colander. PE350U



AC14

**Basket Waste**

Push down to seal, pull up to drain and strain. Remove to empty. All sinks



AC51

**Stainless Steel Drainer Basket**

Drain, rinse or stack. Can be used inside the bowl or on the drainer. Solitaire



AC71

**Stainless Steel Drainer Basket**

Drain, rinse or stack. Can be used inside the bowl or on the drainer. Dallas, Monet

MH885/6  
MH885U/6U  
MH886-1



AC03

**Stainless Steel Drainer Basket**

Drain, rinse or stack. Can be used inside the bowl or on the drainer. DU430U

PE Sinks



AC53

**Stainless Steel Utility Tray**

Extends the versatility of your Solitaire by providing extra space. Solitaire



AC73

**18/10 Stainless Utility Tray**

Extends the versatility of your sink by providing extra space. Dallas, Monet

MH885/6  
MH885U/6U  
MH886-1



AC16

**Benchtop Drainer Tray**

Protects your benchtop when draining dishes or defrosting food. All except Solitaire



AC02

**3/4 Bowl Colander**

The perfect place to strain pasta or rinse vegetables and fits into bowl. DU430U



AC18

**'D' Colander**

The perfect place to strain pasta or rinse vegetables and fits into bowl. PE350U



AC72

**'D' Colander**

The perfect place to strain pasta or rinse vegetables and fits into bowl. Dallas, Monet

MH885/6  
MH885U/6U  
MH886-1



AC89

**Stainless Steel Basin Protector**

Protects the basin from scratching and provides extra defrosting area. Titan



AC80

**Stainless Steel Basin Protector**

Protects the basin from scratching and provides extra defrosting area. Manhattan



AC81

**Stainless Steel Basin Protector**

Protects the basin from scratching and provides extra defrosting area. Dallas



AC82

**Stainless Steel Basin Protector**

Protects the basin from scratching and provides extra defrosting area. MH885U/6U

MH886-1  
Dallas



**Accessories suitable for all sinks in the range specified unless indicated by bowl size icon**

See page 18 for bowl sizes.



www.oliverisinks.com

## Tapware | The perfect partner

Oliveri tapware has been selected from the world's finest manufacturers. In order to wear the Oliveri signature it must be of the highest quality, elegant in design and functional. The taps are carefully chosen to complement the clean lines of your Oliveri sink while performing with the utmost reliability when connected to a variety of hot and cold water systems.

### Versatile and practical

Rinse efficiently in spray mode; reach effortlessly with the extendable neck.



### MV617/6 extendable spray head mixer

From washing vegetables to filling large pots, the Oliveri MV617/6 is a kitchen essential. This European made mixer tap features an extendable shower head that delivers either spray or stream at the flick of a button. It also includes a clever 'soft opening' device which reduces splashes. Like all Oliveri tapware, it is of the highest quality, elegant in design and functional, sourced from one of the world's finest manufacturers.

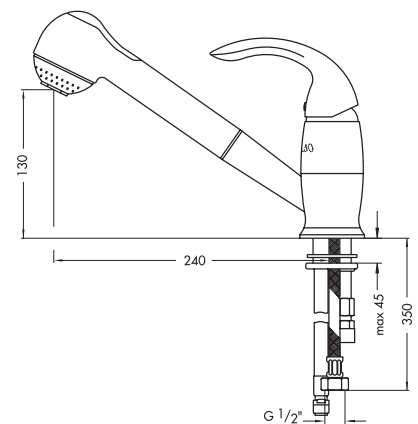



### MG513 mixer tap with gooseneck spout

This tall, elegant mixer tap has smooth curves to accompany the modern design of the larger Oliveri sinks. A generous spout height allows plenty of room to get the biggest roasting dish underneath, while the simple one-touch control lever responds instantly to your command. This European-made beauty will further enhance the finest Oliveri sinks.

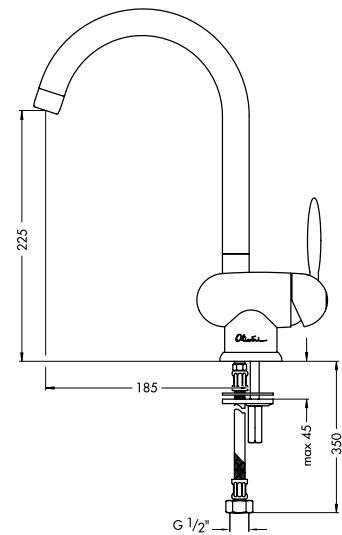

### PS113/1 single lever sink mixer

This timeless design incorporates a generous reach swivelling spout with a handle that is smooth and light to operate as well as being easy to keep clean. Finished in bright chrome, this European-made mixer tap is very much at home on any Oliveri sink. The subtle Oliveri signature on the control handle is your sign of quality.

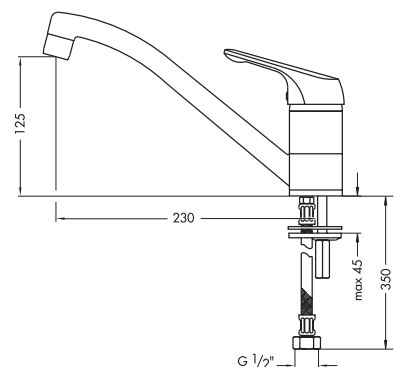

Oliveri Tapware is only available from selected outlets and is suitable for mains pressure water systems.



www.oliverisinks.com

# Specifications & dimensions

**Titan Bowl**  
710 x 405 x 255mm deep  
TN Sinks  
35 Litre Capacity

**Superb Bowl**  
510 x 455 x 255mm deep  
MH Sinks  
48 Litre Capacity

**45 Litre Mega Bowl**  
520 x 400 x 255mm deep  
DU490U  
45 Litre Capacity

**Gourmet Bowl**  
375 x 485 x 255mm deep  
DA Sinks  
39 Litre Capacity

**NP Bowl**  
380 x 420 x 200mm deep  
NP Sinks  
30 Litre Capacity

**Extra Capacity Bowl**  
350 x 420 x 180mm deep  
MO Sinks  
24 Litre Capacity

**Extra Capacity Bowl 2**  
350 x 420 x 180mm deep  
MH / DA / MO450U Sinks  
24 Litre Capacity

**Round Bowl**  
420 x 180mm deep  
LR Sinks  
24 Litre Capacity

**Large Capacity Bowl**  
330 x 400 x 180mm deep  
PE Sinks  
21 Litre Capacity

**Main Bowl**  
330 x 385 x 155mm deep  
DU430U  
17 Litre Capacity

**¾ Bowl**  
280 x 350 x 130mm deep  
MO455U  
11 Litre Capacity

**¾ Bowl**  
270 x 330 x 155mm deep  
DU485U  
12 Litre Capacity

**½ Bowl**  
215 x 350 x 130mm deep  
MO / MH Sinks  
9 Litre Capacity

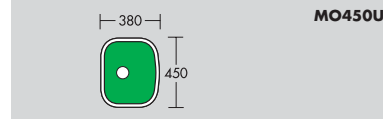
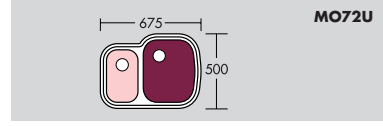
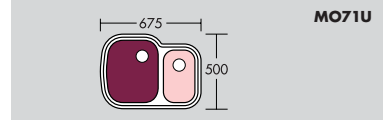
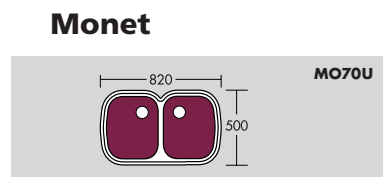
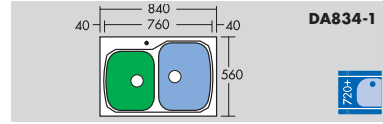
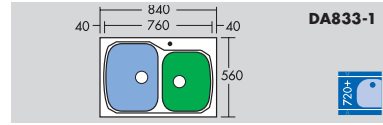
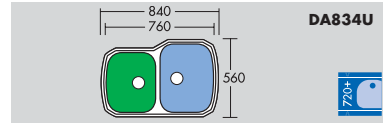
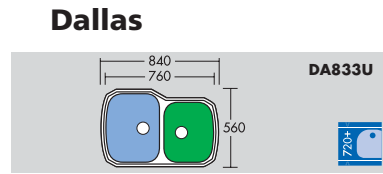
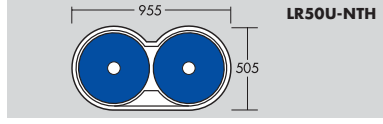
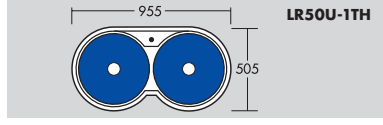
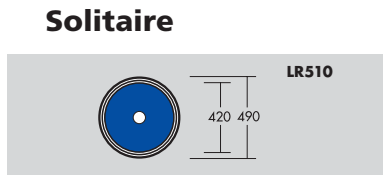
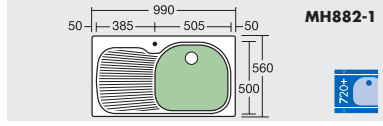
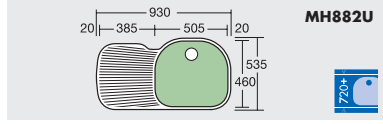
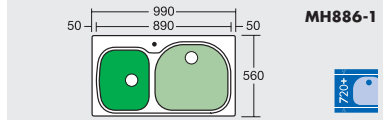
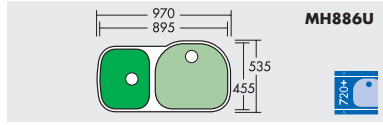
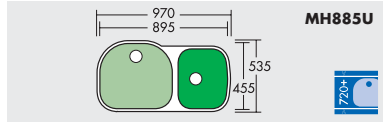
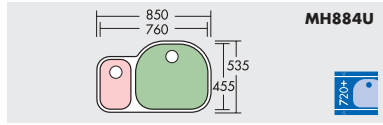
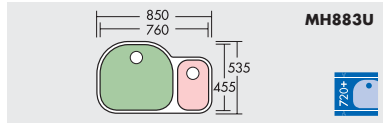
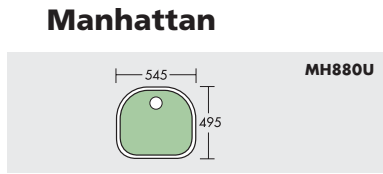

**720+** Wide Bench Tops  
Minimum 720mm bench top required for installation.

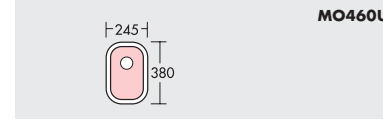
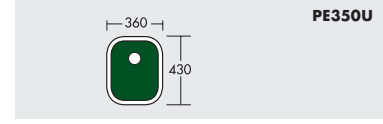
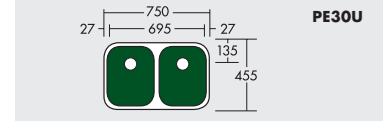
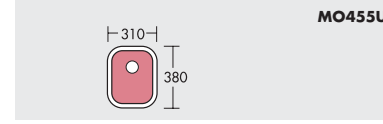
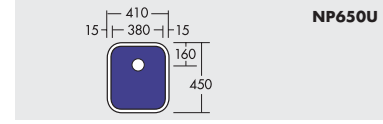
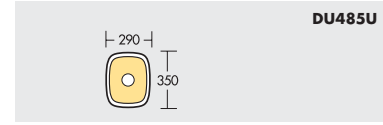
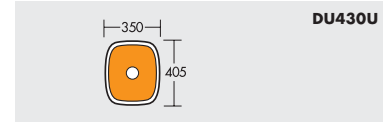
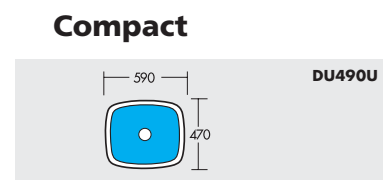
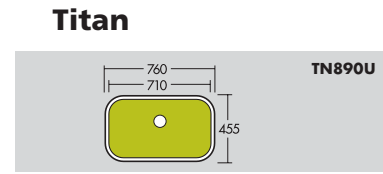

## Cut Out Sizes

Sink Model	Cut Out Size (mm)	Shipping Weight (kg)	Sink Model	Cut Out Size (mm)	Shipping Weight (kg)
<b>Manhattan</b>			<b>Solitaire</b>		
MH880U	Template supplied in carton	7.0	LR510	Template supplied in carton	10.0
MH883U, MH884U	Template supplied in carton	12.0	LR50U-1TH	466mm diam TOPMOUNT	4.0
MH885U, MH886U	Template supplied in carton	15.0	LR50U-NTH	454mm diam UNDERMOUNT	
MH886-1	970 x 540mm	15.0	<b>Titan</b>		
MH882U	Template supplied in carton	14.0	TN890U	Template supplied in carton	11.0
MH882-1	970 x 540mm	14.0	<b>Compact</b>		
<b>Dallas</b>			DU490U	Template supplied in carton	9.0
DA833U, DA834U	Template supplied in carton	13.0	DU430U	Template supplied in carton	4.5
DA833-1, DA834-1	820 x 540mm	13.0	DU485U	Template supplied in carton	4.0
<b>Monet</b>			NP650U	Template supplied in carton	5.0
MO70U	Template supplied in carton	8.0	MO455U	Template supplied in carton	2.0
MO71U, MO72U	Template supplied in carton	7.0	PE30U	Template supplied in carton	6.0
MO450U	Template supplied in carton	4.5	PE350U	Template supplied in carton	4.5
			MO460U	Template supplied in carton	2.0



**DA834U** (Shown with AC73 and optional MG513 Mixer Tap)



**LR50U-1TH** (Shown with AC53 and optional AC50 & MV617/6 Mixer Tap)



**MO70U** (Shown with AC72, AC74, AC73 & optional PS113/1 Mixer Tap)



## World Class Manufacturing

Over the years, the Oliveri signature has earned its reputation as a mark of excellence in design, function and durability. Overseas markets have also been impressed by the quality and innovative accessories that complement every Oliveri sink. Export sales continue to grow, further establishing Oliveri as one of the world's best stainless steel sinks.

The company began life as a general, domestic and metal fabricator in 1948. The founders pioneered the deep drawing technology in Australia, creating seamless, deep drawn stainless steel bowls.

Tasman Sinkware will continue to develop designs and styles suitable for any application where the highest standards are demanded.

## Care & Maintenance

Oliveri sinks are manufactured from genuine 18/10, 304 grade stainless steel, for optimum hygiene and durability. However, no stainless steel sink was ever designed to do battle against hardened metal utensils or food processor blades, without incurring at least a few scratches.

The best prevention against scratching is to exercise a little extra care, or even to use one of Oliveri's accessory baskets when washing cutlery and the like.

To maintain the shine on your Oliveri sink, regular maintenance is recommended with any of the easy to obtain, non-abrasive stainless steel cleaners or metal polishes.

## Genuine Oliveri

Beware of imitations as no one can match the quality and design of Oliveri sinks and accessories.

The Oliveri signature embossed into the stainless steel surface, as well as the distinctive Australian style packaging, ensures that your sink is a genuine Oliveri.

## Contemporary Collection

Oliveri's range of inset stainless steel sinks.



## Individually Inspected

Each Oliveri sink is individually inspected for quality of construction and finish.

Raw materials are sourced worldwide, and must satisfy the highest standards before being accepted into the manufacturing process.

Tasman Sinkware currently produce their sinks and tubs to "world standard" best practice. The company is Quality Endorsed and all products are manufactured to Standard ISO 9001-2000, your guarantee of quality.

Current designs reflect the most modern and innovative styles and are crafted to suit even the most discerning homeowner.



### Head Office / Export Enquiries

#### Tasman Sinkware Pty Ltd

ABN 12 007 551 886  
PO Box 2141 Regency Park  
SA 5942 Australia  
Phone 61 8 8348 6444  
Fax 61 8 8348 6495  
Website [www.oliverisinks.com](http://www.oliverisinks.com)  
Email [sinkware@tasbuildpro.com.au](mailto:sinkware@tasbuildpro.com.au)

#### Australia

For more information call 1300 13 SINK (1300 13 7465) to be connected directly to your nearest brand or sales agent (not available from mobiles).



A division of Fletcher Building

**Adelaide**  
(08) 8348 6444

**Brisbane**  
(07) 3299 2133

**Canberra**  
(02) 6280 5736

**Darwin**  
(08) 8947 2101

**Hobart**  
(03) 6273 1355

**Tasman Sinkware North America\***  
1230 Railroad Street,  
Corona, CA 92882  
[northamerica@oliverisinks.com](mailto:northamerica@oliverisinks.com)

**Melbourne**  
(03) 9587 1933

**Perth**  
(08) 9446 5711

**Sydney**  
(02) 9602 2322

**Townsville**  
(07) 4775 4096

**Wagga Wagga**  
(02) 6922 8600

**New Zealand\***  
**Dux Industries Ltd**  
0800 FORDUX (0800 367 389)  
[dux@dux.co.nz](mailto:dux@dux.co.nz)

**Singapore\***  
**Sim Siang Choon Ltd**  
6266 6632  
[sims@simsiangchoon.com](mailto:sims@simsiangchoon.com)

**Hong Kong\***  
**Deacon & Co Ltd**  
2369 6111  
[imports@deacon.com.hk](mailto:imports@deacon.com.hk)

**United Kingdom\***  
**A.C.Toon Ltd**  
01246 223900  
[sales@actoon.co.uk](mailto:sales@actoon.co.uk)

**Canada\***  
**Aquabrass**  
(514) 381 4141

\*Ranges, specifications and accessory options may vary outside Australia

## Look for the brand with the blue dot



[www.oliverisinks.com](http://www.oliverisinks.com)

Available from



© Registered trademark of Tasman Sinkware. Under its policy of ongoing product development Tasman Sinkware may from time to time change product specification without notice. WARNING: Products in this brochure and all literature pertaining to, are subject to Intellectual Property Protection. All dimensions given are approximate and should be checked prior to installation. Product colour reproduction is as near to actual as printing methods allow.